

Weighing module Novego®

Hygienic all-in-one solution for reliable weighing of vessels



German Quality



! Your benefits

- Hygienic weighing module ensures efficient cleaning
- High degree of process reliability and precision thanks to the innovative side-force-resistant system
- Quick and easy commissioning due to smart add-on parts
- Durable, reliable weighing solution with excellent corrosion resistance



The weighing module Novego® was specifically developed to meet the increasingly stringent requirements of the food industry. This hygienic all-in-one solution boasts a range of innovative properties to ensure simple, error-free installation and maximum resistance to lateral forces.

Unique on the market: reliable measurement accuracy – even with high side forces

- ! Minimum **sensitivity to side forces**: the weighing module Novego® reliably absorbs lateral forces. The six strain gauges ensure maximum measurement accuracy and prevent incorrect quantities, even when using mixers.
- ! The **built-in height adjuster and innovative tilt correction** for sloped surfaces ensure intuitive installation of the Novego®, meaning it is ready for operation immediately.
- ! The **optimal accessibility** of all components enables quick, easy and efficient cleaning, and prevents soiling.
- ! The high **product quality and corrosion resistance** of the Novego® reduce set-up costs and machine downtime.

Novego®: one weighing module, a world of advantages

Novego® ensures process reliability, measurement accuracy and rapid cleaning. The exceptional corrosion resistance of the stainless steel and the product design in accordance with EHEDG guidelines make the weighing module resistant to dirt, water and even aggressive cleaning products.



Hygienic Design





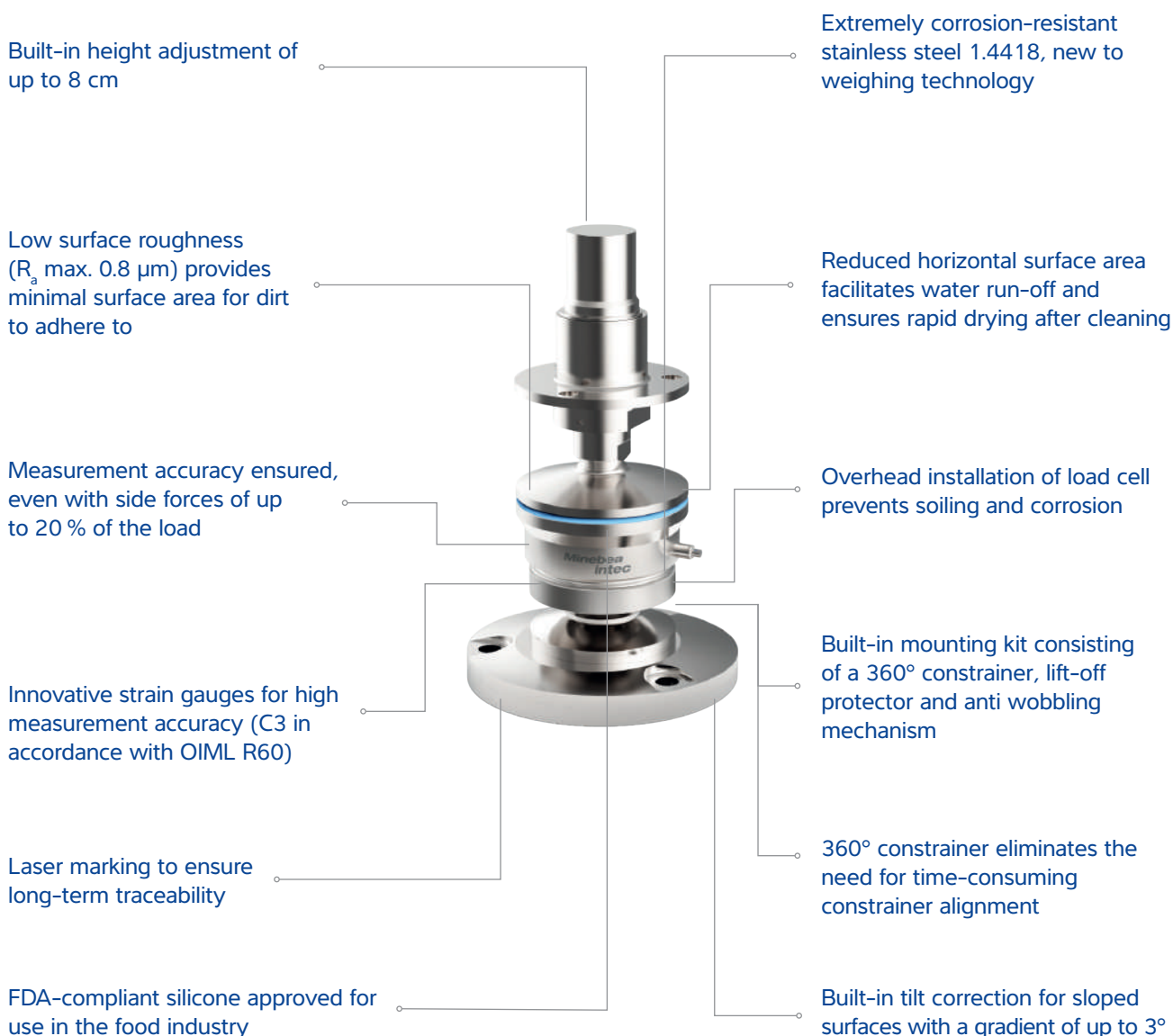

The weighing module Novego® was developed in line with the stringent design standards of the European Hygienic Engineering and Design Group (EHEDG).

Technological advancement is the sum of many small details

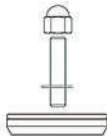
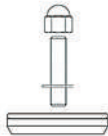
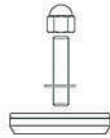

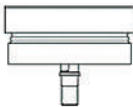
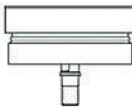
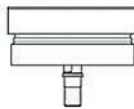
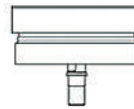
Everything you need for easy installation, built-in: mounting kit with height adjuster and tilt correction

Novego® offers innovative features for the food industry that ensure simple, error-free installation. By choosing this weighing module, you are opting for rapid, precise, hygienic assembly, and save yourself additional, time-consuming constringer alignment.

Weighing module Novego® product configuration				
Adapter plate				
	Novego/00S	Novego/00S	Novego/00S	Novego/01S
Load cell				
	Novego 125 ... 2.000 kg C3	Novego 125 ... 2.000 kg C3	Novego 125 ... 2.000 kg C3	Novego 125 ... 2.000 kg C3
Pendulum base				
	Novego/02S rack-mounted	Novego/03S floor-mounted	Novego/04S tilt correction for floor mounting	Novego/04S tilt correction for floor mounting

Error-free installation and exceptional corrosion resistance

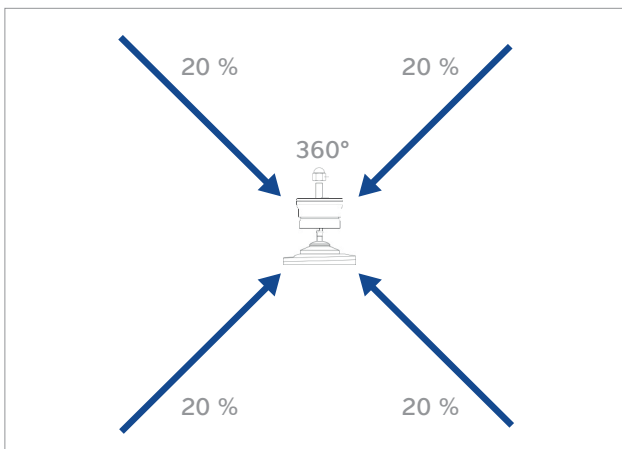

Simple installation without time-consuming constringer alignment: the built-in 360° constringer makes incorrect assembly impossible. In addition, reliable compensation for side forces of up to 20% of the load ensures consistent, precise measurement results.

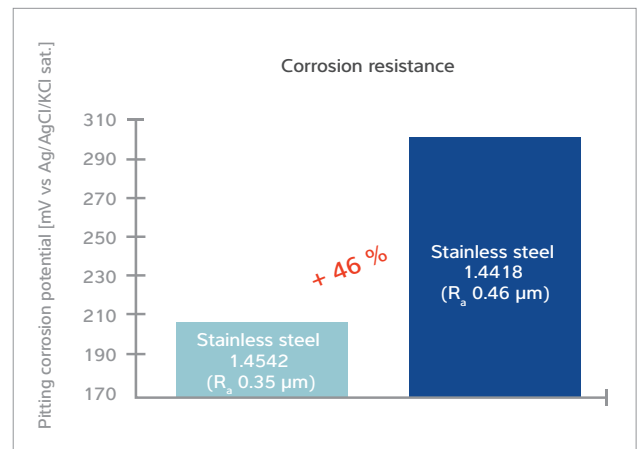

The stainless steel 1.4418 used to make the Novego® has a maximum roughness (Ra) of 0.8 µm, thereby meeting EHEDG requirements. It is especially corrosion-resistant and durable, as proven by the pitting corrosion potential of stainless steel 1.4542 as used in conventional load cells as compared to the stainless steel 1.4418 used for the Novego®.

Protection class and country-specific explosion protection certificates

Protection classes IP68 and IP69, in accordance with DIN EN 60529. The load cell can be submerged in water to a depth of 1.5 m for 10,000 hours, and is spray-proof. The weighing module is suitable for explosion sub-group IIC.

Designation of the load cell for potentially explosive atmospheres

Zone	Designation	Certificate no.	For
0 and 1	II 1G Ex ia IIC T6 Ga Ex ia IIC T6 Ga 0Ex ia IIC T6 (*)	BVS 16 ATEX E 005 IECEX BVS 16.0005	Only PR 6261/..E (Novego ..E)
20 and 21	II 1D Ex ta IIIC T160°C Da Ex ta IIIC T160°C Da Ex ta IIIC T160°C X (*)	TÜV 03 ATEX 2301 X IECEX TUN 17.0025X	Only PR 6261/..E (Novego ..E)
2	II 3G Ex nA IIC T6 Gc 2Ex nA IICT6X (*)	Manufacturer's declaration	All PR 6261 (Novego)
22	II 3D Ex tc IIIC T85 °C Dc Ex tc IIIC T85 °C X (*)	Manufacturer's declaration	All PR 6261 (Novego)
	Ambient temperature in Ex-Area -30... +55 °C		
	(*) only with approval TP TC 012 (TRCU 012) -52...+55 °C		



Built-in tilt correction and height adjuster

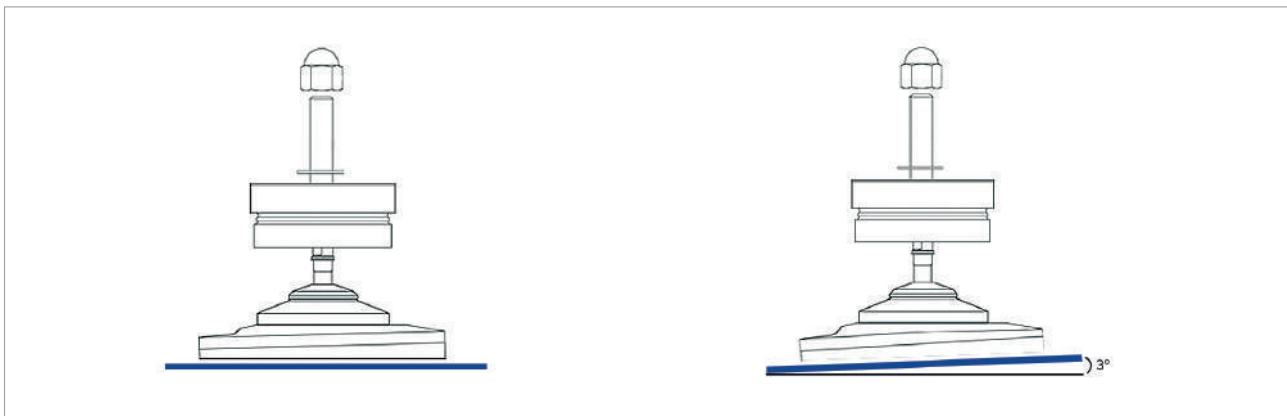

Built-in tilt correction for sloped surfaces with a gradient of up to 3°

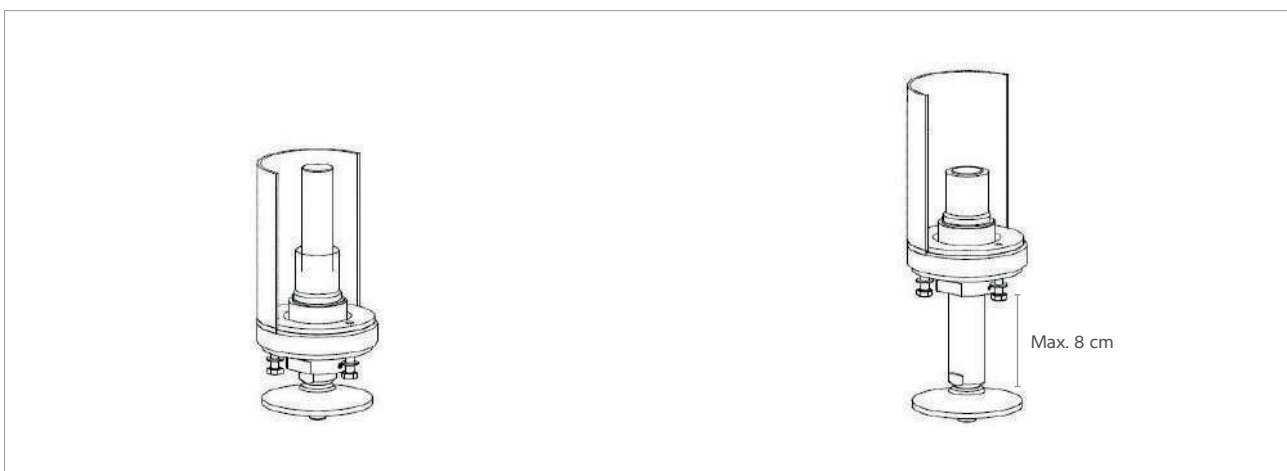

Built-in height adjuster to balance out vessel feet

Dimensions of individual components

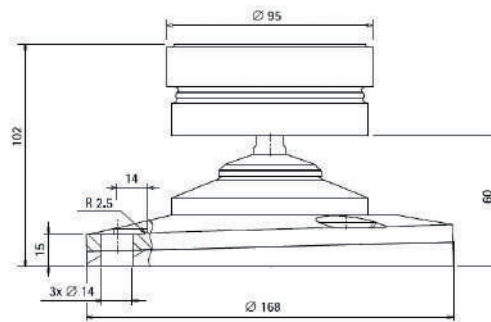

Dimensions of the load cell Novego® and pendulum base with tilt correction for floor mounting Novego®/04S

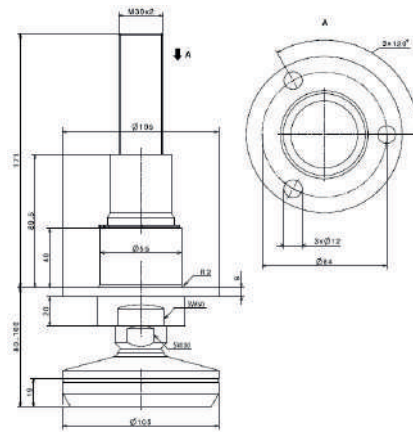

Dimensions and drilling pattern for height adjuster Novego®/01S

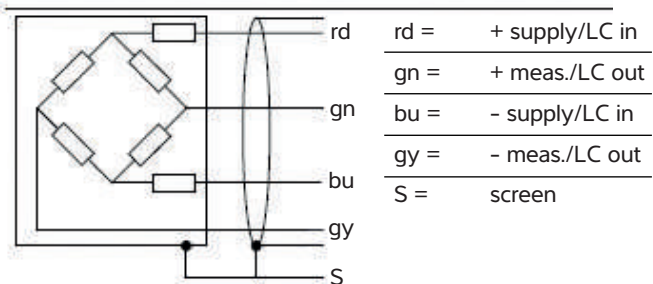

Connection diagram

Ordering information

Ordering information for the load cell

Type	Packaging (mm)	Weight gross/net (kg)	Order number
Novego/125 kg C3	approx. 290x210x120	approx. 1.7/approx. 1.4	940526103112
Novego/250 kg C3	approx. 290x210x120	approx. 1.7/approx. 1.4	940526103125
Novego/500 kg C3	approx. 290x210x120	approx. 1.7/approx. 1.4	940526103150
Novego/1t C3	approx. 290x210x120	approx. 1.7/approx. 1.4	940526103210
Novego/2t C3	approx. 290x210x120	approx. 1.7/approx. 1.4	940526103220

Ordering information for add-on parts

	Type	Description	Packaging (mm)	Weight gross/net (kg)	Order number
Pendulum	PR 6061/02S	Pendulum base for rack mounting	approx. 255x255x65	approx. 1.8/1.3	940536061022
	PR 6061/03S	Pendulum base for floor mounting	approx. 255x255x65	approx. 2.9/2.5	940536061032
	PR 6061/04S	Pendulum base for floor mounting with built-in tilt correction	approx. 255x255x65	approx. 4.8/4.2	940536061042
Adapter plate	PR 6061/00S	Adapter plate with threaded bolts	approx. 147x125x50	approx. 1.2/1.1	940536061002
	PR 6061/01S	Adapter plate with built-in height adjuster	approx. 425x105x100	approx. 3.7/3.3	940536061012
	PR 6061/05S	Shim set	approx. 200x130x40	approx. 1.6/1.4	940536061052
	PR 6061/06S	Transport and assembling Kit	approx. 190x140x40	approx. 0.3/0.2	940536061062
	PR 6061/07S	Pivot	approx. 290x210x120	approx. 2.6/2.2	940536061072

Ordering information for the load cell version for potentially explosive atmospheres

Type	Packaging (mm)	Weight gross/net (kg)	Order number
Novego/125 kg C3E	approx. 290x210x120	approx. 1.7/approx. 1.4	940566103112
Novego/250 kg C3E	approx. 290x210x120	approx. 1.7/approx. 1.4	940566103125
Novego/500 kg C3E	approx. 290x210x120	approx. 1.7/approx. 1.4	940566103150
Novego/1t C3E	approx. 290x210x120	approx. 1.7/approx. 1.4	940566103210
Novego/2t C3E	approx. 290x210x120	approx. 1.7/approx. 1.4	940566103220

Ordering information for accessories

Type	Accessories		Dimensions	Weight gross/net (kg)
PR 6130/64Sa	Cable junction box for use in potentially explosive atmospheres	Material: stainless steel 1.4301, IP68, IP69 for all industrial, intrinsically safe and verifiable applications, for up to 4 load cells	190x160x60 mm	approx. 1.4/approx. 1.2
PR 6130/65S	Cable junction box for use in potentially explosive atmospheres	Material: rust-proof stainless steel 1.4301, IP68, IP69 for all industrial, intrinsically safe and verifiable applications, for up to 4 load cells	172x105x55 mm	approx. 1.0/approx. 0.75
PR 6130/34Sa	Cable junction box	Material: rust-proof stainless steel 1.4301, IP68, IP69 for all industrial, verifiable applications, for up to 4 load cells	190x160x60 mm	approx. 1.3/approx. 1.0
PR 6130/35S	Cable junction box	Material: rust-proof stainless steel 1.4301, IP68, IP69 for all industrial, verifiable applications, for up to 4 load cells	172x105x55 mm	approx. 0.8/approx. 0.6
PR 6135	Installation cable	For all applications, grey	D = 9 mm	
PR 6135/A	Installation cable, reinforced	For all applications, grey	D = 13 mm	
PR 6136	Installation cable	For all intrinsically safe applications, blue	D = 11 mm	
PR 6136/A	Installation cable, reinforced	For all intrinsically safe applications, blue	D = 13 mm	



Technical data – weighing module Novego®

Parameter	Description	Abbr.	C3*	Unit
Accuracy class			0.015	% E _{max}
Minimum dead load	Lowest limit of specified measuring range	E _{min}	0	% E _{max}
Maximum capacity	Highest limit of specified measuring range	E _{max}	125, 250, 500, 1,000, 2,000	kg
Safe load limit	Maximum load without irreversible damage	E _{lim}	150	% E _{max}
Destructive load	Danger of mechanical destruction	E _d	>300	% E _{max}
Max. permissible lifting force	To still hold the specified performance afterwards		100	% E _{max}
Destructive lifting force	Danger of mechanical destruction (by lifting)		>300 but max. 3 t	% E _{max}
(Nominal) side force range	Range of side force to hold the specified performance	QK _n	<20	% load
Side force limit	Maximum side force without irreversible damage	E _{lq}	For 125 kg: 200 For 250/500 kg: 150 For 1 t, 2t: 100 (max. 1 t)	% E _{max}
Minimum LC verification	Minimum load cell verification interval $v_{min} = E_{max} / Y$	Y	14,000	
Deadload output return	Factor for dead load output return after load (DR=½*E _{max} /Z)	Z	3,000	
Rated output	Relative output at maximum capacity	C _n	2	mV/V
Tolerance on rated output	Permissible deviation from rated output	d _c	<0.07	% C _n
Zero output signal	Load cell output signal under unloaded condition	S _{min}	0 to 1.5	% C _n
Repeatability error	Max. change in load cell output for repeated loading	ε _R	<0.005	% C _n
Creep, during 30 min	max.change in load cell output under E _{max}	d _{cr}	<0.016	% C _n
Non-linearity	Max. deviation from best straight line through zero	d _{lin}	<0.01	% C _n
Hysteresis	Max. difference in LC output between loading and unloading	d _{hy}	<0.016	% C _n
Temperature effect on S _{min}	Max. change of S _{min} over B _T	TK _{Smin}	<0.01	% C _n /10K
Temperature effect on C	Max. change of C over B _T	TK _C	<0.01	% C _n /10K
Input impedance	Between supply terminals	R _{LC}	1,080±10	Ω
Output impedance	Between measuring terminals	R _O	1,010±1	Ω
Insulation impedance	Between measuring circuit and housing at 100 V _{DC}	R _{IS}	>5,000	MΩ
Insulation voltage	Between circuit and housing (Novego ..E only)		500	V _{DC}
Recommended supply voltage	To hold the specified performance	B _U	4 to 20	V
Max. supply voltage	Permissible for continuous operation without damage	U _{max}	24	V
Nominal ambient temp. range	To hold the specified performance	B _T	-10 to +40	°C
Usable ambient temp. range	Permissible for continuous operation without damage	B _{Tu}	-40 to +95	°C
Storage temperature range	Transportation and storage	B _{Ti}	-40 to +95	°C
Permissible eccentricity	Permissible displacement from nominal load line	S _{ex}	±2.5	mm
Vibration resistance	Resistance against oscillations (IEC 68-2-6 Fc)		20 g, 100 h, 10 to 150 Hz	
Air pressure effect	Influence of ambient air pressure on S _{min}	PK _{Smin}	<17	g/kPa
Nominal deflection	Max. elastic deformation under nominal load For E _{max} ≤ 500 kg For E _{max} ≥ 1 t	S _{nom}	Max. 0.1 Max. 0.2	mm
Material (sensor)			1.4418 (DIN EN 10088-3)	
Material (pendulum base)			1.4301 and 1.4418 (DIN EN 10088-3)	
Protection class			IP68 + IP69	
Cables			TPE, colour: grey, ø 5 mm, 4 x 0.35 mm ² Novego ..E TPE, colour: blue, ø 5 mm, 4 x 0.35 mm ²	
Cable bending radius			≥25 mm in case of fixed installation ≥75 mm in case of flexible installation	

* According to OIML R60

The technical data given serves as a product description only and should not be understood as guaranteed properties in the legal sense.

Specifications subject to change without notice.